

Series
NKV



■ **Applications**

Duct water heaters are designed for heating of supply air in round ventilation systems. They can be also applied in supply or supply and exhaust ventilating units.

■ **Design**

The heater casing is made of galvanized steel, the tubular coils are of copper tubes and the heat exchange surface is made of aluminium plates. The heaters are equipped with rubber seals for airtight connection to the air ducts. The heaters are available in 2 and 4 rows modifications and are designed for maximum operating pressure 1.6 MPa (16 bar) and maximum water operating temperature +100°C. The outlet manifold has a branch pipe for installation of submersible temperature probe or icing protecting device. The heater is equipped with a nipple for the system deaeration.

■ **Mounting**

- ▶ The heater design ensures its mounting on the round ducts in any position by means of clamps. The water heating coils can be installed in any position that enables the heater deaeration. The air flow direction shall match the pointer designation on the heater.
- ▶ The mounting shall be performed in such a way as to enable the uniform air stream distribution along the whole cross section.
- ▶ The air filter shall be installed at the heater inlet to protect the heating elements against pollution.
- ▶ The heater can be installed at the fan inlet or outlet. If the heater is located at the filter outlet the air duct between the heater and the filter shall have the length of at least two connecting diameters to ensure the air flow stabilization as well as permissible air temperature level inside the fan.
- ▶ The heater shall be connected on the counterflow principle, otherwise its efficiency can drop by 5-15%.

All the nomographic charts in the catalogue are valid for such connection.

- ▶ If water serves as a heat medium the heaters are suitable for indoor installation only. For outdoor installation use antifreeze mixture, i.e. ethylene glycol solution.
- ▶ To ensure the correct and safe heater operation use the automation system that provides complex control and freezing protection:
 - ✓ automatic control of heating elements capacity and air heating temperature;
 - ✓ Switching ventilating system on after preliminary heating with the heater;
 - ✓ use of air curtains equipped with spring-loaded actuator;
 - ✓ filter checking by means of differential pressure sensor;
 - ✓ fan shutdown in case of the heater freezing danger.

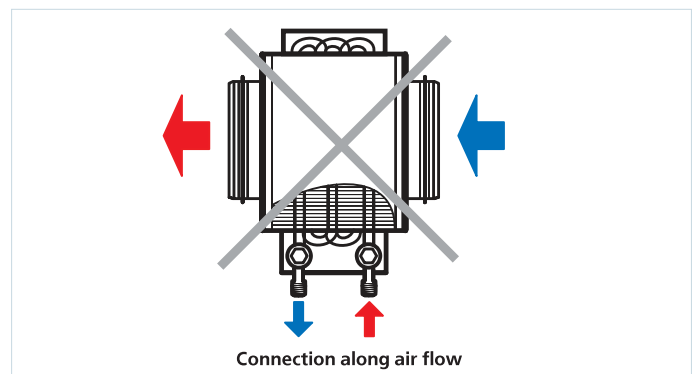
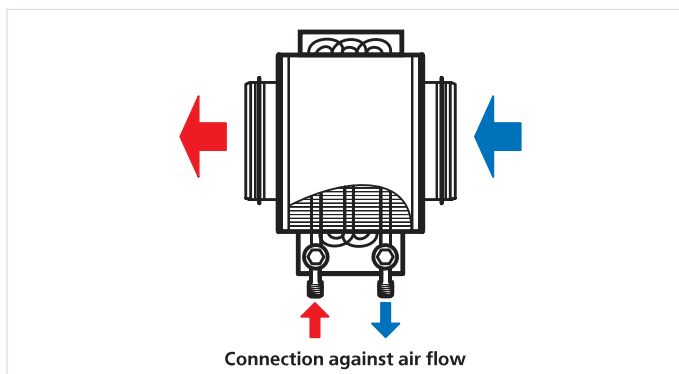

Designation key:

Series	Flange diameter, [mm]	-	Number of water coil rows
NKV	100; 125; 150; 160; 200; 250; 315		2; 4

Accessories



page 322

Overall dimensions:

Type	Dimensions [mm]									Number of water coil rows	Mass [kg]
	∅D	B	H	H3	L	L1	L2	L3	K		
NKV 100-2	99	350	230	150	300	32	43	220	G 3/4"	2	3,9
NKV 100-4	99	350	230	150	300	28	65	220	G 3/4"	4	5,2
NKV 125-2	124	350	230	150	300	32	43	220	G 3/4"	2	4,0
NKV 125-4	124	350	230	150	300	28	65	220	G 3/4"	4	5,3
NKV 150-2	149	400	280	200	300	32	43	220	G 3/4"	2	7,5
NKV 150-4	149	400	280	200	300	28	65	220	G 3/4"	4	8,2
NKV 160-2	159	400	280	200	300	32	43	220	G 3/4"	2	7,5
NKV 160-4	159	400	280	200	300	28	65	220	G 3/4"	4	8,2
NKV 200-2	198	400	280	200	300	32	43	220	G 3/4"	2	7,5
NKV 200-4	198	400	280	200	300	28	65	220	G 3/4"	4	8,2
NKV 250-2	248	470	350	270	350	32	43	270	G 1"	2	10,3
NKV 250-4	248	470	350	270	350	28	65	270	G 1"	4	10,8
NKV 315-2	313	550	430	350	450	57	43	370	G 1"	2	12,6
NKV 315-4	313	550	430	350	450	53	65	370	G 1"	4	13,4

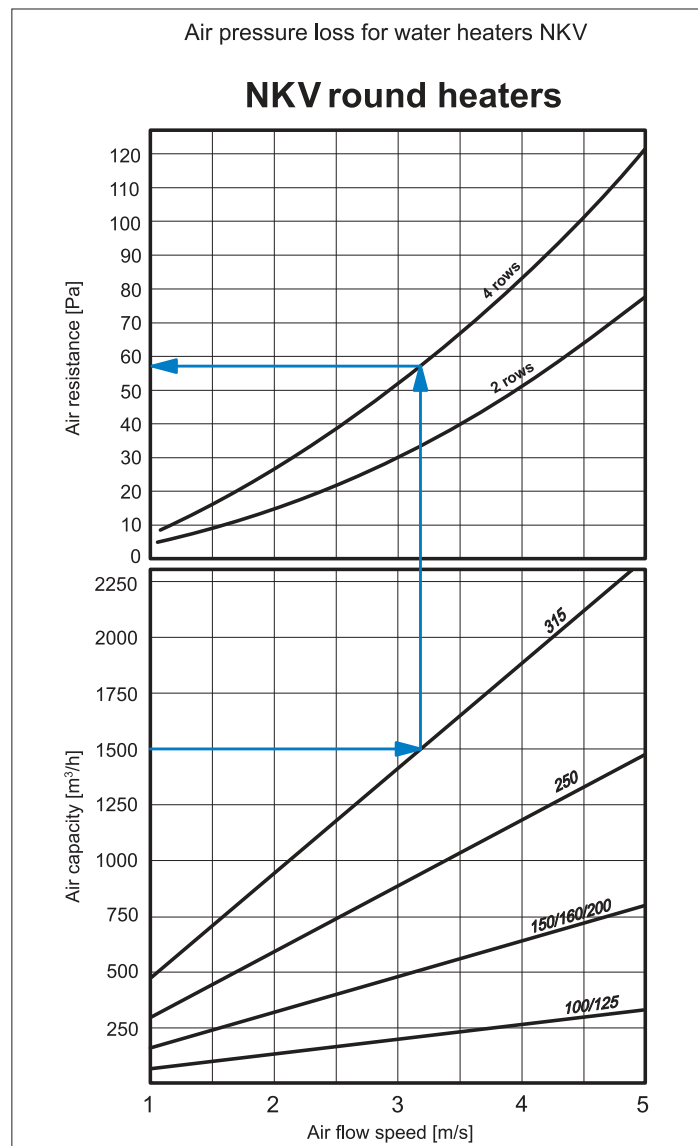
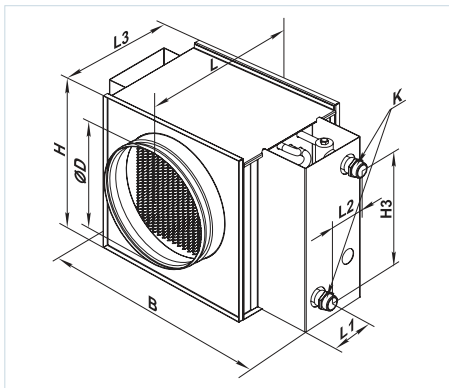

NKV

Air temperature after heater [°C]
5 10 15 20 25 30 35 40 45 50 55

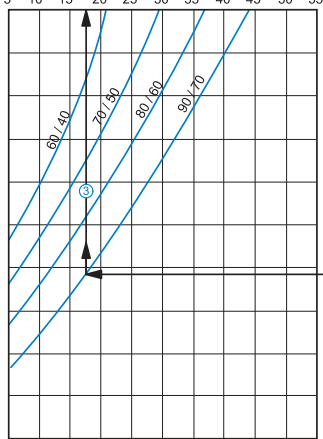

NKV 100-2 / NKV 125-2

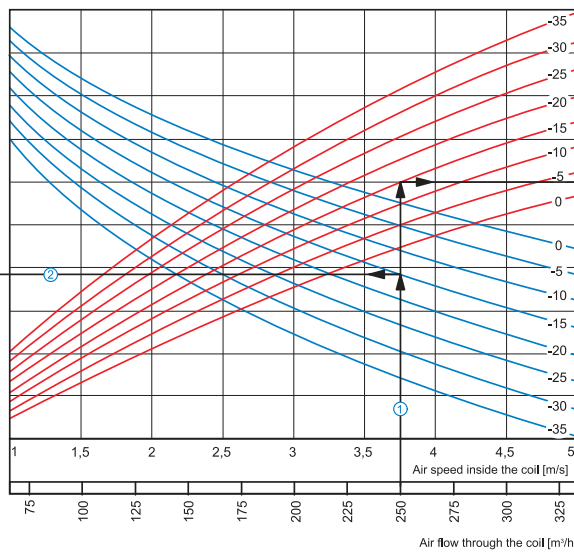

Coil heating capacity [kW]
0.5 1 1.5 2 2.5 3 3.5 4 4.5 5

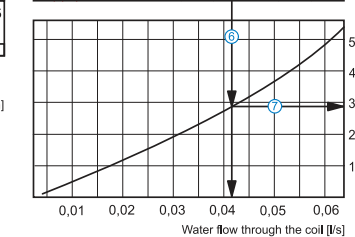
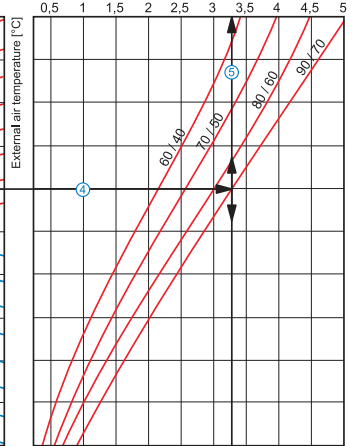

How to use water heater diagrams

- Air Speed. Starting from 250 m³/h on the air flow scale draw a vertical line ① till the air speed axis which makes about 3.75 m/s.
- Supply air temperature. Prolong the line ① up to the point where it crosses the outside air temperature (blue curve), e.g. -15°C; then draw a horizontal line ② from this point to the left till crossing water in/out temperature curve (90/70 °C). From this point draw a vertical line ③ to the supply air temperature axis on top of the graphic (+17,5°C).
- Heating coil capacity. Prolong the line ① up to the point where it crosses the outside air temperature -15°C (red curve) and draw a horizontal line ④ from this point to the right until it crosses water in/out temperature curve (90/70 °C), from here draw a vertical line ⑤ up to the scale representing the heating coil capacity (3.25 kW).
- Water flow. Prolong the line ⑤ down to water flow axis at the bottom of the graphic ⑥ (0.042 l/s).
- Water pressure drop. Draw the line ⑦ from the point where line ⑥ crosses the black curve to the pressure drop axis. (2.9 kPa).

NKV

Air temperature after heater [°C]
15 20 25 30 35 40 45 50 55 60 65

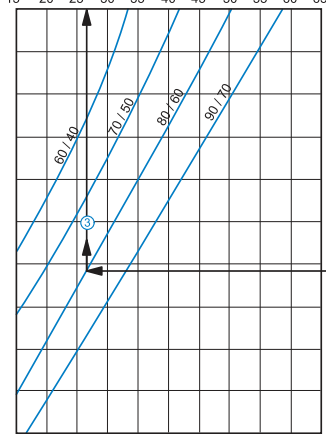

NKV 100-4 / NKV 125-4

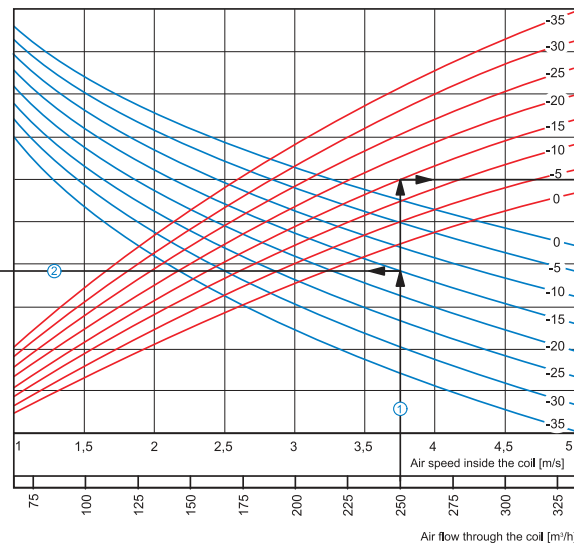

Coil heating capacity [kW]
1 2 3 4 5 6 7 8 9 10

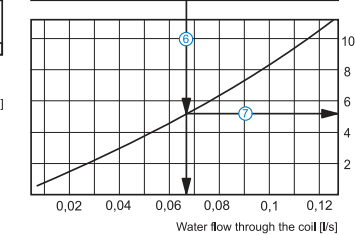
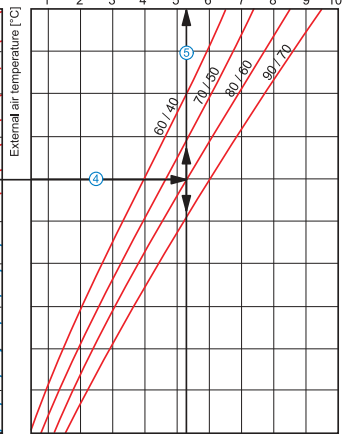

How to use water heater diagrams

- Air Speed. Starting from 250 m³/h on the air flow scale draw a vertical line ① till the air speed axis which makes about 3.75 m/s.
- Supply air temperature. Prolong the line ① up to the point where it crosses the outside air temperature (blue curve), e.g. -15°C; then draw a horizontal line ② from this point to the left till crossing water in/out temperature curve (80/60 °C). From this point draw a vertical line ③ to the supply air temperature axis on top of the graphic (+27°C).
- Heating coil capacity. Prolong the line ① up to the point where it crosses the outside air temperature indicated as red curve (e.g., -15°C) and draw a horizontal line ④ from this point to the right to the intersection of water in/out temperature curve (e.g., 80/60 °C). From this point draw a vertical line ⑤ up to the scale of heating coil capacity (5.2 kW).
- Water flow. Prolong the line ⑤ down to water flow axis at the bottom of the graphic ⑥ (0.067 l/s).
- Water pressure drop. Draw the line ⑦ from the point where line ⑥ crosses the black curve to the pressure drop axis. (5.2 kPa).

NKV

Air temperature after heater [°C]

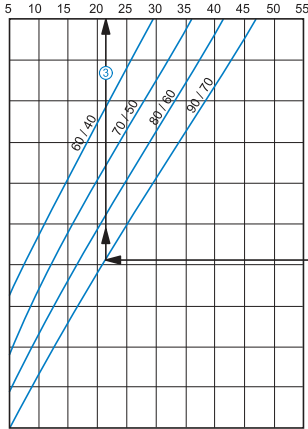

NKV 150-2 / NKV 160-2 / NKV 200-2

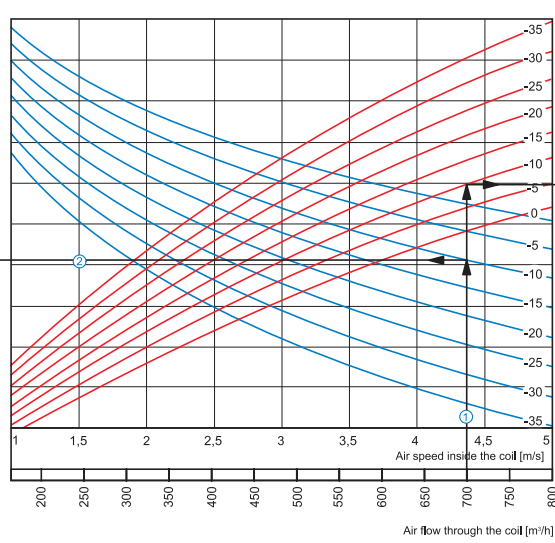

Coil heating capacity [kW]

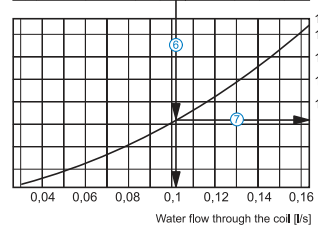
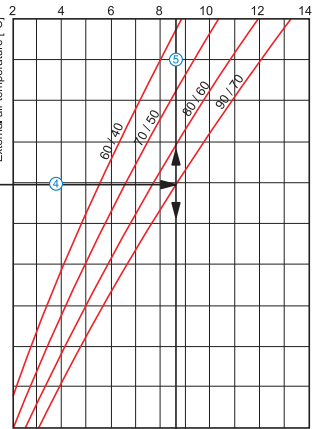

How to use water heater diagrams

Air Speed. Starting from 700 m³/h on the air flow scale draw a vertical line ① till the air speed axis which makes about 4.4 m/s.

■ **Supply air temperature.** Prolong the line ① up to the point where it crosses the outside air temperature (blue curve), e.g. -10°C; then draw a horizontal line ② from this point to the left till crossing water in/out temperature curve (90/70 °C). From this point draw a vertical line ③ to the supply air temperature axis on top of the graphic (+21 °C).

■ **Heating coil capacity.** Prolong the line ① up to the point where it crosses the outside air temperature indicated as red curve (e.g., -10°C) and draw a horizontal line ④ from this point to the right to the intersection of water in/out temperature curve (e.g., 90/70 °C). From this point draw a vertical line ⑤ up to the scale of heating coil capacity (8.6 kW).

■ **Water flow.** Prolong the line ⑥ down to water flow axis at the bottom of the graphic (0.11 l/s).

■ **Water pressure drop.** Draw the line ⑦ from the point where line ⑥ crosses the black curve to the pressure drop axis. (8.2 kPa).

NKV

Air temperature after heater [°C]

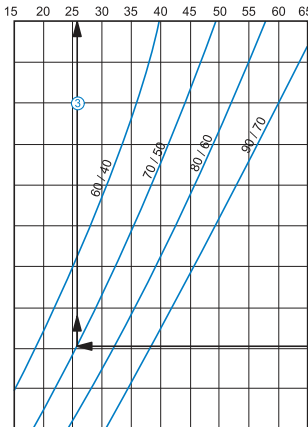

NKV 150-4 / NKV 160-4 / NKV 200-4

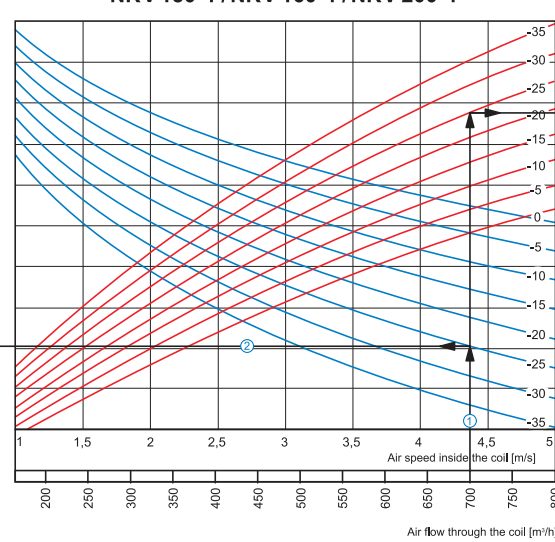

Coil heating capacity [kW]

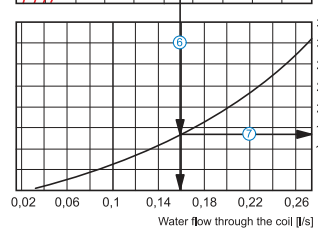
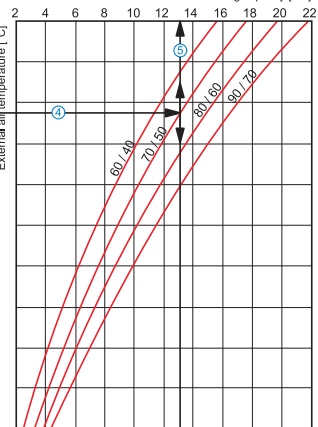

How to use water heater diagrams

Air Speed. Starting from 700 m³/h on the air flow scale draw a vertical line ① till the air speed axis which makes about 4.4 m/s.

■ **Supply air temperature.** Prolong the line ① up to the point where it crosses the outside air temperature (blue curve), e.g. -25°C; then draw a horizontal line ② from this point to the left till crossing water in/out temperature curve (70/50 °C). From this point draw a vertical line ③ to the supply air temperature axis on top of the graphic (+26 °C).

■ **Heating coil capacity.** Prolong the line ① up to the point where it crosses the outside air temperature indicated as red curve (e.g., -25°C) and draw a horizontal line ④ from this point to the right to the intersection of water in/out temperature curve (e.g., 70/50 °C). From this point draw a vertical line ⑤ up to the scale of heating coil capacity (13.0 kW).

■ **Water flow.** Prolong the line ⑥ down to water flow axis at the bottom of the graphic (0.16 l/s).

■ **Water pressure drop.** Draw the line ⑦ from the point where line ⑥ crosses the black curve to the pressure drop axis. (15 kPa).

NKV

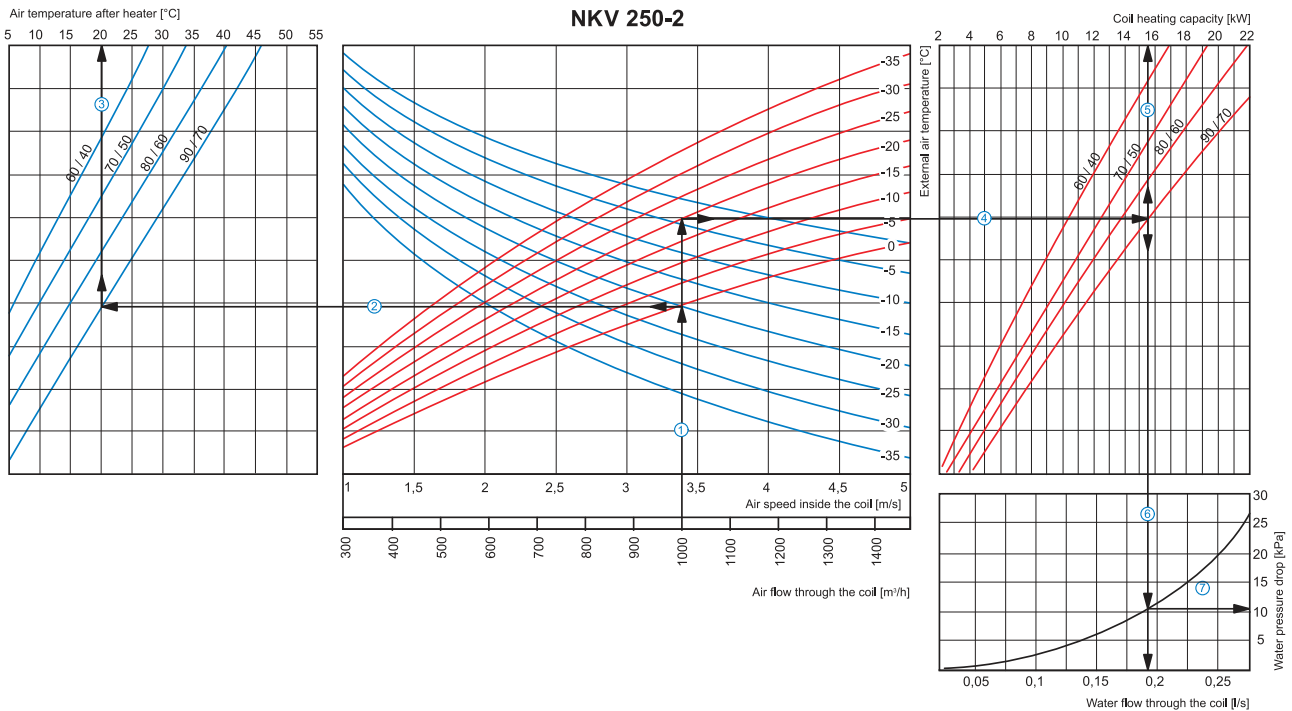

How to use water heater diagrams

- Air Speed. Starting from 1000 m³/h on the air flow scale draw a vertical line ① till the air speed axis which makes about 3.4 m/s.
- Supply air temperature. Prolong the line ① up to the point where it crosses the outside air temperature (blue curve), e.g. -20°C; then draw a horizontal line ② from this point to the left till crossing water in/out temperature curve (90/70 °C). From this point draw a vertical line ③ to the supply air temperature axis on top of the graphic (+20 °C).
- Heating coil capacity. Prolong the line ① up to the point where it crosses the outside air temperature indicated as red curve (e.g., -20°C) and draw a horizontal line ④ from this point to the right to the intersection of water in/out temperature curve (e.g., 90/70 °C). From this point draw a vertical line ⑤ up to the scale of heating coil capacity (15.5 kW).
- Water flow. Prolong the line ⑤ down to water flow axis at the bottom of the graphic ⑥ (0.21 l/s).
- Water pressure drop. Draw the line ⑦ from the point where line ⑥ crosses the black curve to the pressure drop axis. (11.0 kPa)

NKV

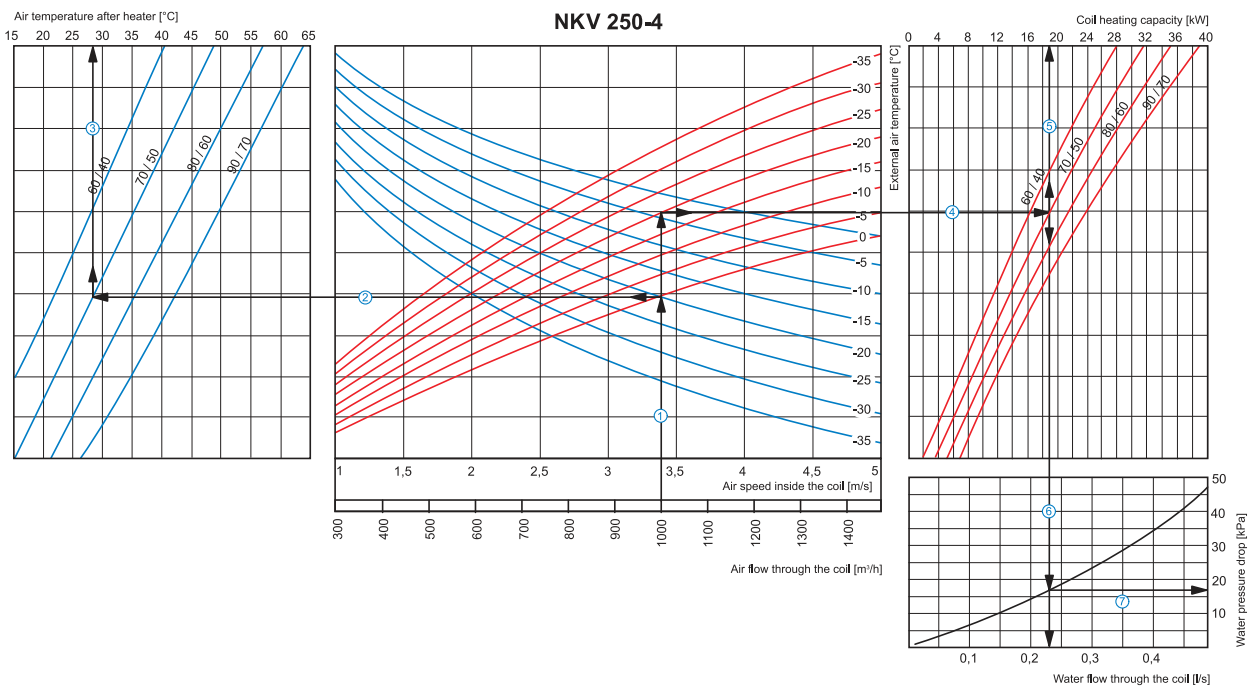

How to use water heater diagrams

- Air Speed. Starting from 1000 m³/h on the air flow scale draw a vertical line ① till the air speed axis which makes about 3.4 m/s.
- Supply air temperature. Prolong the line ① up to the point where it crosses the outside air temperature (blue curve), e.g. -20°C; then draw a horizontal line ② from this point to the left till crossing water in/out temperature curve (70/50 °C). From this point draw a vertical line ③ to the supply air temperature axis on top of the graphic (+28 °C).
- Heating coil capacity. Prolong the line ① up to the point where it crosses the outside air temperature indicated as red curve (e.g., -20°C) and draw a horizontal line ④ from this point to the right to the intersection of water in/out temperature curve (e.g., 70/50 °C). From this point draw a vertical line ⑤ up to the scale of heating coil capacity (19.0 kW).
- Water flow. Prolong the line ⑤ down to water flow axis at the bottom of the graphic ⑥ (0.23 l/s).
- Water pressure drop. Draw the line ⑦ from the point where line ⑥ crosses the black curve to the pressure drop axis. (17.0 kPa).

NKV

Air temperature after heater [°C]
5 10 15 20 25 30 35 40 45 50 55

NKV 315-2

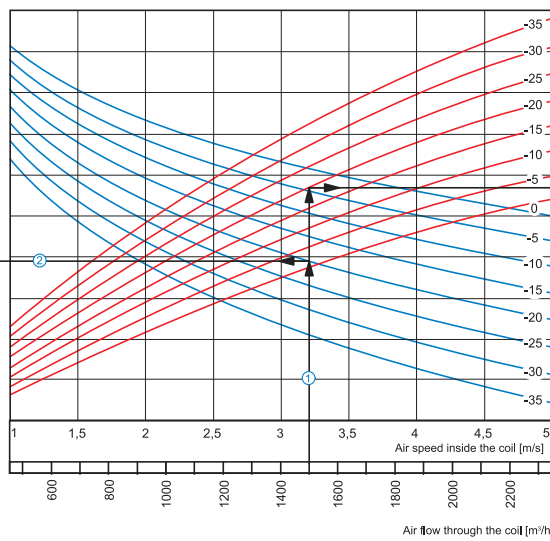
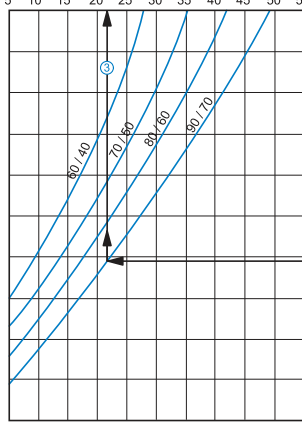

Coil heating capacity [kW]
4 8 12 16 20 24 28 32 36

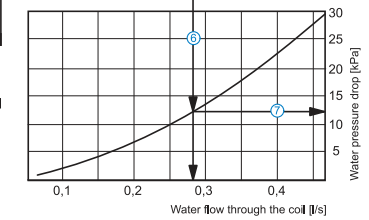
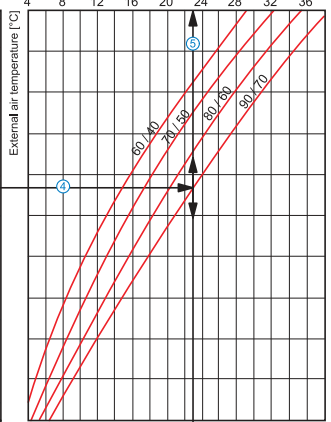

How to use water heater diagrams

Air Speed. Starting from 1500 m³/h on the air flow scale draw a vertical line ① till the air speed axis which makes about 3.2 m/s.

■ **Supply air temperature.** Prolong the line ① up to the point where it crosses the outside air temperature (blue curve), e.g. -20°C; then draw a horizontal line ② from this point to the left till crossing water in/out temperature curve (90/70 °C). From this point draw a vertical line ③ to the supply air temperature axis on top of the graphic (+21 °C).

■ **Heating coil capacity.** Prolong the line ① up to the point where it crosses the outside air temperature (e.g. -20°C, red curve) and draw a horizontal line ④ from this point to the right until it crosses water in/out temperature curve (e.g., 90/70 °C), from here draw a vertical line ⑤ up to the scale representing the heating coil capacity (23.0 kW).

■ **Water flow.** Prolong the line ⑤ down to water flow axis at the bottom of the graphic ⑥ (0.28 l/s)

■ **Water pressure drop.** Draw the line ⑦ from the point where line ⑥ crosses the black curve to the pressure drop axis. (12.5 kPa).

NKV

Air temperature after heater [°C]
15 20 25 30 35 40 45 50 55 60 65

NKV 315-4

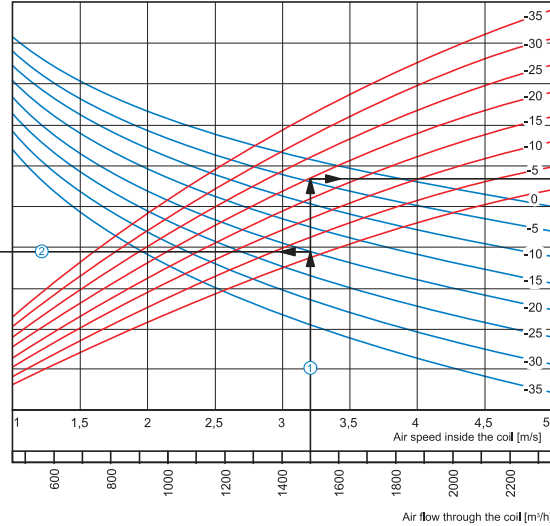
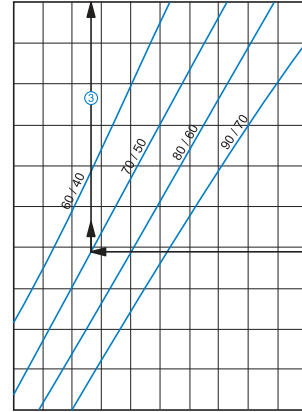

Coil heating capacity [kW]
0 10 20 30 40 50

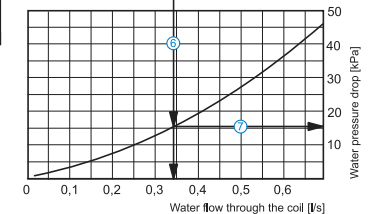
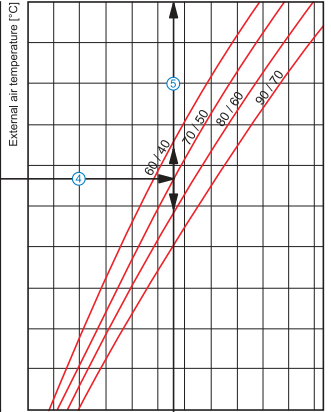

How to use water heater diagrams

Air Speed. Starting from 1500 m³/h on the air flow scale draw a vertical line ① till the air speed axis which makes about 3.2 m/s.

■ **Supply air temperature.** Prolong the line ① up to the point where it crosses the outside air temperature (blue curve), e.g. -20°C; then draw a horizontal line ② from this point to the left till crossing water in/out temperature curve (70/50 °C). From this point draw a vertical line ③ to the supply air temperature axis on top of the graphic (+28 °C).

■ **Heating coil capacity.** Prolong the line ① up to the point where it crosses the outside air temperature (e.g. -20°C, red curve) and draw a horizontal line ④ from this point to the right until it crosses water in/out temperature curve (e.g., 70/50 °C), from here draw a vertical line ⑤ up to the scale representing the heating coil capacity (28.0 kW).

■ **Water flow.** Prolong the line ⑤ down to water flow axis at the bottom of the graphic ⑥ (0.34 l/s).

■ **Water pressure drop.** Draw the line ⑦ from the point where line ⑥ crosses the black curve to the pressure drop axis. (16.0 kPa).